

LIST PRICE GUIDE - 2021

FOR SHOWERING & TEMPERING PRODUCTS

Division of Acorn Engineering Company®, Member of Morris Group International™



ACORN
CONTROLS®

2021 LIST PRICE GUIDE FOR SHOWERING & TEMPERING PRODUCTS
Division of Acorn Engineering Company®, Member of Morris Group International™
PRICES SUBJECT TO CHANGE / All Pricing in US\$ / effective June 14, 2021

See page 20 for 2021 Parts Pricing

L1P00026AC21-A



2021 LIST PRICE GUIDE FOR SHOWERING & TEMPERING PRODUCTS

Division of Acorn Engineering Company®, Member of Morris Group International™

Terms/Conditions of Sales & Warranty

Prices: Prices of the Company's Products are subject to change without notice. Quotations are conditioned upon acceptance within 30 days unless otherwise stated and are subject to correction for typographic or clerical errors. Sales order confirmation will be considered accepted by Buyer if objection is not submitted in writing to Acorn Customer Service within (1) one week of receipt. The sales order confirmation is the governing document. All prices exclude sales, use, occupation, license, excise and other taxes in respect to manufacture or delivery. Unless a proper exemption certificate is furnished to the Company, all such taxes shall be paid by the Buyer to Company at the time of payment.

Term and Conditions of Payment: Terms of payment are Net 30 from date of invoice. Past due accounts will be subject to a 2% per month service charge from the date of the invoice. If any proceedings be instructed by or against Buyer under any bankruptcy or insolvency law, or if Buyer shall fail to make timely payment on this or any other order, or if, in the Company's judgment, Buyer's financial situation justifies such action, the Company may, at its election, require payment in advance or cancel the order as to any unshipped item and require payment of its reasonable cancellation charges. If Buyer delays completion of manufacture, the Company may elect to require payment according to percentage of completion. Equipment held for Buyer shall be at Buyer's risk and expense. In all cases, regardless of partial payment, title to the Products shall remain in the Company until payment for the Products (including any notes given therefore) has been made in full. Should legal action be necessary to enforce payment of an unpaid invoice, the Buyer will assume full responsibility for any court costs and reasonable attorney fees. All orders are subject to credit check and approval prior to shipment.

The minimum order value is \$100 NET. In the event an order is received under that stated minimum order value, a \$25.00 "minimum invoice service charge" will be applied to the order but at no time will the minimum order exceed \$100.00 NET before shipping, handling and taxes. All service charges are non-refundable.

Return Goods Authorization: No materials shall be returned without a Return Goods Authorization (RGA) from Acorn Field Service. Returns must reference the RGA number and be shipped freight prepaid or the shipment will not be accepted. Credit issued for the return will apply only to future shipments and will be subject to a 35% handling charge. Any cost associated with restoring product to saleable condition will be deducted from the credit and any outgoing freight charges paid by Acorn. RGA credit will not be issued for less than \$100.00 unless material is proven defective.

Delivery: Shipments are F.O.B. Factory, Industry, California or other designated shipping point determined by Acorn. FFA (full freight allowed) may be earned on all shipments over \$2,000.00 net; FFA applies to single shipments only. Any shipment or delivery dates quoted by the Company are estimated. The Company shall be obligated to use reasonable efforts to meet such dates. The Company will in no event be liable for any delays in delivery or failure to give notice of delay, or for any other failure to perform hereunder due to causes beyond the reasonable control of the Company. Such causes shall include, but not be limited to acts of God, the elements, acts or omissions of manufacturers or suppliers of the Products or parts thereof, acts or omissions of Buyer or civil and military authorities, fires, labor disputes or any other inability to obtain the Products, parts thereof, or necessary power, labor, materials or supplies. The Company will be entitled to refuse to make, or to delay any shipments of the Products if Buyer shall fail to pay when due any payment owed by it to the Company, whether under this or any other contract between the Company and Buyer. Shipments are normally sent prepay or charge. A surcharge of \$8.00 handling will be added to each small parcel package shipment.

Claims and Shortages: F.O.B. factory shipments are the full responsibility of the Buyer. Losses or damages must be reported to the carrier immediately. Acorn will file freight claims on FFA orders if the Buyer complies with the following within (5) five days of receipt of shipment; inspect shipment immediately, have delivering carrier inspect shipment, file inspection report with carrier, and send a copy to Acorn. No claim for failure to receive shipment or shortage will be honored unless Acorn is notified immediately upon receipt of invoice or within five working days of receipt of shipment, whichever is sooner.

Specifications: Approved submittals must be provided to Acorn Controls in writing before an order will be considered accepted. All products are subject to change without notice. Unless stated in the purchase order, material will be furnished per the design in effect at the time the order is filled. Field dimensions must be submitted in writing and are the full responsibility of the Buyer. Changes in specifications or cancellations must be submitted in writing to Acorn for review, the Buyer will be subject to charges incurred due to the extent of the change or cancellation.

Force Majeure: Morris Group International companies will not be liable for any failure or delay in performing an obligation that is due to any of the following causes: acts of God, accident, riots, war, terrorist act, epidemic, pandemic, quarantine, civil commotion, breakdown of communication facilities, breakdown of web host, breakdown of internet service provider, natural catastrophes, governmental acts or omissions, changes in laws or regulations, national strikes, fire, explosion, transportation issues or generalized lack of availability of raw materials or energy.

Origin & Far Compliance: SUPPLIER reserves the right to furnish either foreign or domestic material unless otherwise specified by the customer at the time of quotation and noted on the subsequent purchase order. Requirements for product compliance and certification with the Buy American Act, Buy America Act, and any other Federal Acquisition Regulation shall be noted on the purchase order. Failure to document domestic and federal procurement requirements on the purchase order shall result in PURCHASER assuming all liability and replacement costs for products determined to be non-compliant.

LIMITED WARRANTY

Acorn warrants that all of its products are guaranteed against defective material or poor workmanship for a period of one year from date of shipment. Acorn's liability under this warranty shall be discharged by replacing without charge F.O.B. City of Industry, California, any goods, or part thereof, which appear to the company upon inspection to be of defective material or not of first-class workmanship, provided that claim is made in writing to the company within reasonable period after receipt of the product. Where claims for defects are made, the defective part or parts shall be delivered to the company, prepaid, at City of Industry, California for inspection. Acorn will not be liable for the cost of repairs, alterations or replacement, or for any expense connected therewith made by the owner or his agents, except upon written authority from the Acorn City of Industry office. Acorn will not be liable for any damages caused by defective materials or poor workmanship, except for replacements, as above provided. Buyer agrees that Acorn has made no other warranties either expressed or implied in addition to those above stated, except that of title with respect to any of the products or equipment sold hereunder and that Acorn shall not be liable for general, special or consequential damages claimed to arise under the contract of sale. All designs are subject to change without notice. Unless stated in the order, material will be furnished of the design in effect at the time the order is filled.

**TERMS, CONDITIONS & WARRANTY ARE
SUBJECT TO CHANGE. ALWAYS REFER TO
ONLINE DOCUMENT AT
ACORN-CONTROLS.COM**

www.Acorn-Controls.com
AcornControls@Acorneng.com



2021 LIST PRICE GUIDE FOR SHOWERING & TEMPERING PRODUCTS

Division of Acorn Engineering Company®, Member of Morris Group International™

PRICES SUBJECT TO CHANGE / All Pricing in US\$ effective June 14, 2021

Temperature/Pressure Balancing Mixing Valve for Individual Showers

SV16 Series

ASSE 1016 T/P Certified



Automatic compensating valve for Individual Shower and Combination Tub/Showers; ADA, Ligature Resistant, Tri-Lever Handle or Level Handle versions are available.

Flow Rate is 4 GPM @ 45 PSID









Patented: D697,591 & 10,474,170

Model	Description	Price
SV16	T/P Shower, ADA, Ligature Resistant, Tri-Lever Handle	\$305
SV16-LVR	T/P Shower, ADA Lever Handle	\$305

SUMMARY OF KEY PRODUCT FEATURES

- IAPMO Certified to ASSE 1016 T/P at 1.25 GPM
- Ceramic Shut-off Components
- Non-Rising Stem
- Lead-Free Components w/DZR Brass
- Standard Ligature-Resistant or Lever Handle Trim
- Matching Ligature Resistant or Lever Trim Diverter
- FULL RANGE ADA
- Single Control Handle Turns on Cold to Hot
- Reversible Control Cartridge
- Dual Sweat Threaded Connections
- 4 GPM @ 45 psid
- 5° F Approach Temperature
- Accessible Replaceable Screens
- Patented Valve & Trim

SV16 Options

Showerheads	Description	Add Price
	CSH15 Conical Ligature Resistant Showerhead, Chrome Plated Brass with Press. Comp. 1.5 GPM (5.7 LPM) Flow Control; Non-adj. Fixed Spray, 35° Angle	\$188
	CSH25 Conical Ligature Resistant Showerhead, Chrome Plated Brass with Press. Comp. 2.5 GPM (9.5 LPM) Flow Control; Non-adj. Fixed Spray, 35° Angle	\$188
	ESH15 Econo-Showerhead, Chrome Plated ABS with Press. Comp. 1.5 GPM (5.7 LPM) Flow Control; Adjustable Spray, 2" Diameter, Ball Joint	\$14
	ESH25 Econo-Showerhead, Chrome Plated ABS with Press. Comp. 2.5 GPM (9.7 LPM) Flow Control; Adjustable Spray, 2" Diameter, Ball Joint	\$12
	LSH15 Large Showerhead, Chrome Plated Brass with Press. Comp. 1.5 GPM (5.7 LPM) Flow Control; Adjustable Spray, 3" Diameter, Ball Joint	\$62
	LSH25 Large Showerhead, Chrome Plated Brass with Press. Comp. 2.5 GPM (9.7 LPM) Flow Control; Adjustable Spray, 3" Diameter, Ball Joint	\$50
	SH15 Showerhead, Chrome Plated Brass with Press. Comp. 1.5 GPM (5.7 LPM) Flow Control; Narrow Pattern Adjustable Spray, 1-3/4" Diameter Ball Joint	\$29
	SH25 Showerhead, Chrome Plated Brass with Press. Comp. 2.5 GPM (9.7 LPM) Flow Control; Narrow Pattern Adjustable Spray, 1-3/4" Diameter Ball Joint	\$27
	NSH15 Nozzle Shower Head, 1.5 GPM	\$88
	NSH25 Nussle Shower Head, 2.5 GPM	\$88







2021 LIST PRICE GUIDE FOR SHOWERING & TEMPERING PRODUCTS

Division of Acorn Engineering Company®, Member of Morris Group International™

PRICES SUBJECT TO CHANGE / All Pricing in US\$ effective June 14, 2021

SV16 Options Continued...

Add Price

			Add Price
ARM AND FLANGE			
	BA	Deluxe with set screw (competition's standard is not deluxe)	\$21
TUB SPOUTS			
	TUB1	1/2 and 3/4" Brass with Diverter	\$64
	TUB2	1/2 and 3/4" Zinc with Diverter	\$33
	TUB3	1/2' Slip Fit with Diverter	\$33
	TUB4	1/2' Slip Fit without Diverter	\$21
HAND SHOWER HANDLES			
	HHC15	Deluxe Chrome, 1.5 GPM	\$29
	HHW15	Standard White, 1.5 GPM	\$22
HAND SHOWERS HOSE			
	HSSH	Stainless Steel, 60"	\$29
	HHVH	White Vinyl, 60"	\$19
HAND SHOWER MOUNTING			
	GR24	Glide Rail 24"	\$128
	GR30	Glide Rail 30"	\$155
	HHGB	Grab Bar Handle Bracket - White	\$15
	HHGBC	Grab Bar Handle Bracket - Chrome	\$29
	HHWB	Wall Hooks - PRICE IS EACH	\$5
DIVERTERS			
	DIV	Concealed - trim to match SV16	\$169
	IDIV	In-Line	\$48
GRAB BARS			
	1108CAP-1	24"	\$162
	1108CAP-4	36"	\$188
VACUUM BREAKERS			
	EVB	Exposed Elevated	\$198
	IVB	In Line	\$25
HAND HELD SUPPLY CONNECTION			
	HHSE	Wall Mount for Hand Shower	\$26
VOLUME CONTROL			
	HV	1/2" IPS Conn. Volume Control	\$23
OTHER OPTIONS			
	QD	Quick Disconnect for Shower	\$78
	RPI	25 pcs Min. Reversed Inlet Ports for one of the valves in each Back-to-Back Installation).	(Typically) \$12
	Project Packing	100 pc. Min. Behind Wall Items packed separately from Trim. shown valid up to 500 pc. Order.	Price \$121
	7800-056-001	Stem Extension	\$23
	MB-SV16	Wall Mounting Bracket	\$23
	7800-005-001	Remodeling Plate	\$58



2021 LIST PRICE GUIDE FOR SHOWERING & TEMPERING PRODUCTS

Division of Acorn Engineering Company®, Member of Morris Group International™

PRICES SUBJECT TO CHANGE / All Pricing in US\$ effective June 14, 2021

Thermostatic Lavatory Tempering Valve

ST70 Series

ASSE 1070 Certified



Automatic temperature mixing valves for group showers, tubs and lavatory faucets; Brass Body, Rough Chrome Body and 2 size/flow rate capacities are available

Patented: 9,898,017

Model	Description	Weight	Price
ST70-12	1/2" NPT Connection Brass Body, 4.5 GPM @ 45 PSID	1 Lb	\$189
ST70CP-12	1/2" NPT Connection Brass Body, Rough Chrome Finish, 4.5 GPM @ 45 PSID	1 Lb	\$224
ST70-38	3/8" Compression Connection Brass Body, 4.0 GPM @ 45 PSID	1 Lb	\$189
ST70-38-BCT	3/8" Compression Connection Brass Body w/Brass Compression Tee, 4.0 GPM @ 45 PSID	1.2 Lb	\$204
ST70CP-38	3/8" Compression Connection Brass Body, Rough Chrome Finish, 4.0 GPM @ 45 PSID	1 Lb	\$224
ST70CP-38-BCT-C	3/8" Compression Connection Brass Body, Rough Chrome Finish, 4.0 GPM @ 45 PSID	1.2 Lb	\$239

Options (prices when sold as a separate line item):

BCT	Option: 3/8" Brass Compression Tee	\$23
BCT-C	Option: 3/8" Brass Compression Tee, Chrome Plated	\$29

SUMMARY OF KEY PRODUCT FEATURES

- IAPMO Certified to ASSE 1070 at 0.25 GPM
- NSF/ANSI 61 Certified Lead Free for potable water
- Cartridge-Style Integral Checks/Screens
- Allen Wrench Temperature Adjustment w/Lock Nut
- 3/8" compression or 1/2" NPT connections
- 4 GPM (3/8") or 4.5 GPM (1/2") @ 45 psid
- 5° F Approach Temperature
- Brass or Chrome Finish



2021 LIST PRICE GUIDE FOR SHOWERING & TEMPERING PRODUCTS

Division of Acorn Engineering Company®, Member of Morris Group International™

PRICES SUBJECT TO CHANGE / All Pricing in US\$ effective June 14, 2021

Thermostatic Lavatory/Shower Tempering Valve

Alpha™ STP7069 Series

ASSE 1070 & 1069 Certified



The Alpha Thermostatic Mixing Valve provides safe tempered water for Sinks, Lavatories and Showers.

Patented: 9,898,017

Model	Description	Weight	Price
STP7069-12S	Alpha Thermostatic Valve, Noryl Body	0.5 Lbs	\$128
STP7069-12S-BCT	Alpha Thermostatic Valve, Noryl Body w/Brass By-Pass Tee	0.5 Lbs	\$153

SUMMARY OF KEY PRODUCT FEATURES

- Certified to ASSE 1070 & 1069 at 0.25 GPM
- Cartridge-Style Integral Checks/Screens
- Allen Wrench Temperature Adjustment w/Lock-Nut
- 1/2" NPSM connections (flex line connection)
- NSF/ANSI 61 Certified lead-free
- 4.5 GPM @ 45 psid
- 5° F Approach Temperature
- Noryl Body/Bonnet

ST7069 Series

ASSE 1070 & 1069 Certified

Water Temperature Limiting
Device for Sinks, Lavatories
and Showers

Patented: 9,898,017



Model	Description	Weight	Price
ST7069	1/2" NPT Connection Brass Body, 12 GPM @ 45 PSID	3.5 Lbs	\$234
ST7069-BVS	W/Optional Inlet Ball Valves	4.1 Lbs	\$313
ST7069-OTG	W/Optional Outlet Temperature Gauge	4.0 lbs	\$355
ST7069-BVS-OTG	W/Inlet Ball Valves and Outlet Temperature Gauge	4.6 lbs	\$418
Options:			Add Price
MB-1	Mounting Bracket for ST7069, MV17-1 and ET71-1	0.2 lbs	\$17

SUMMARY OF KEY PRODUCT FEATURES

- Certified to ASSE 1070 & 1069 at 0.5 GPM
- Cartridge-Style Integral Checks/Screens
- Allen Wrench Temperature Adjustment w/Lock-Nut
- 1/2" NPT connections
- NSF/ANSI 61 Certified lead-free
- 12 GPM @ 45 psid
- 10° F Approach Temperature
- Lead-free/DZR Brass Construction

Thermostatic Lavatory/Tub/Shower Tempering Valve

Omega™ ST7017 Series

ASSE 1017 & 1070 Certified

The Alpha Thermostatic Mixing Valve provides safe



2021 LIST PRICE GUIDE FOR SHOWERING & TEMPERING PRODUCTS

Division of Acorn Engineering Company®, Member of Morris Group International™

PRICES SUBJECT TO CHANGE / All Pricing in US\$ effective June 14, 2021



The Alpha Thermostatic Mixing Valve provides safe tempered water for Sinks, Lavatories and Showers for Flows Ranging from 0 to 25 GPM.

Patented: 9,898,017

Model	Description	Weight	Price
ST7017-12CU	Omega™ Thermostatic Valve, 1/2" Copper	2.2 Lbs	\$298
ST7017-12PEX	Omega™ Thermostatic Valve, 1/2" PEX	2.2 Lbs	\$298
ST7017-12CPVC	Omega™ Thermostatic Valve, 1/2" CPVC	2.2 Lbs	\$298
ST7017-34CU	Omega™ Thermostatic Valve, 3/4" Copper	2.2 Lbs	\$328
ST7017-34PEX	Omega™ Thermostatic Valve, 3/4" PEX	2.2 Lbs	\$328
ST7017-34CPVC	Omega™ Thermostatic Valve, 3/4" CPVC	2.2 Lbs	\$328

SUMMARY OF KEY PRODUCT FEATURES

- Certified to ASSE 1017 & 1070 at 0.25 GPM
- Cartridge-Style Integral Checks/Screens
- Allen Wrench Temperature Adjustment w/Lock-Nut
- 1/2" & 3/4" Copper, PEX and CPVC Connections
- "Lead-Free" Construction
- Up to 21 GPM @ 45 psid
- 5° F Approach Temperature

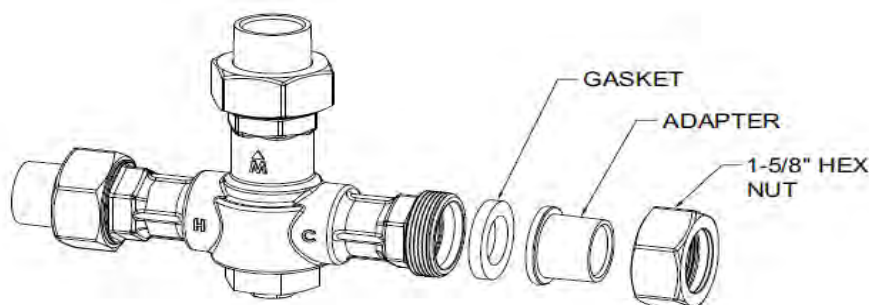



2021 LIST PRICE GUIDE FOR SHOWERING & TEMPERING PRODUCTS

Division of Acorn Engineering Company®, Member of Morris Group International™

PRICES SUBJECT TO CHANGE / All Pricing in US\$ effective June 14, 2021

Lead Free Emergency Fixture Thermostatic Mixing Valve

ET71 Series

ASSE 1071 Certified



Temperature Actuated Mixing Valves for Plumbed Emergency Equipment including eyewashes, eye-face washes, drench showers and hoses and combination units; 4 size/flow rate capacities are available.

Patented: 9,879,658 & 9,989,017

Model	Description	Weight	Price
ET71-1	1/2" NPT Inlet & Outlet, 12 GPM @ 45 PSID	3.5 Lbs	\$657
ET71-1-BVS	w/Full Port Inlet Ball Valves		\$746
ET71-1-OTG	w/Outlet Temperature Gauge		\$797
ET71-1-BVS-OTG	w/Inlet Ball Valves & Outlet Temperature Gauge		\$879
ET71-2	3/4" NPT Inlet, 1" NPT Outlet, 43 GPM @ 45 PSID	8.5 Lbs	\$1,049
ET71-2-BVS	w/Full Port Inlet Ball Valves		\$1,175
ET71-2-OTG	w/Outlet Temperature Gauge		\$1,238
ET71-2-BVS-OTG	w/Inlet Ball Valves & Outlet Temperature Gauge		\$1,364
ET71-3	1" NPT Inlet, 1-1/4" NPT Outlet, 86 GPM @ 45 PSID	36 Lbs	\$1,461
ET71-3-BVS	w/Full Port Inlet Ball Valves		\$1,613
ET71-3-OTG	w/Outlet Temperature Gauge		\$1,655
ET71-3-BVS-OTG	w/Inlet Ball Valves & Outlet Temperature Gauge		\$1,807
ET71-4	1-1/4" NPT Inlet, 1-1/2" NPT Outlet, 150 GPM @ 45 PSID	36 Lbs	\$2,182
ET71-4-BVS	w/Full Port Inlet Ball Valves		\$2,429
ET71-4-OTG	w/Outlet Temperature Gauge		\$2,418
ET71-4-BVS-OTG	w/Inlet Ball Valves & Outlet Temperature Gauge		\$2,665

SUMMARY OF KEY PRODUCT FEATURES

- IAPMO Certified to ASSE 1071 at Advertised Minimum Flow Rate
(IAPMO Certified Minimum Flow Rates from 1.5 to 3 GPM based on capacity)
- Meets ASSE 1017 and ANSI Z358 for Preventing Unauthorized Shut-off without Extra-Cost Cabinets or Lockable Covers
- Recirculation Capable
- Four Models Rated from 12 to 150 GPM @ 45 psid
- Two Inlet-Sized Lockable FULL PORT Ball Valves OPTIONAL
- Cartridge-Style Integral Checks/Screens
- Allen Wrench Temperature Adjustment
- Lock Nut Tamper Resistance
- Minimum Hot Water Supply: 5° F above setpoint
- Available as a Supply Fixture Assembly
- May be Installed in Any Direction
- Unique Patented Cold Water By-Pass





2021 LIST PRICE GUIDE FOR SHOWERING & TEMPERING PRODUCTS

Division of Acorn Engineering Company®, Member of Morris Group International™

PRICES SUBJECT TO CHANGE / All Pricing in US\$ effective June 14, 2021

Options – Lead Free Emergency Fixture Thermostatic Mixing Valve

Options	Description	Add Price
Mounting Brackets		
MB-1	for ET71-1 Valve	\$17
MB-2	for ET71-2 Valve	\$27
MB-3	for ET71-3 & ET71-4 Valve	\$54
Cabinets		
SMC - PRC	CABINET ONLY - See Supply Fixtures for Pre-piped Assemblies	
	for ET71-1 Valve	\$809
	for ET71-2 Valve	\$856
	for ET71-3 Valve or ET71-4 Valve	\$908
SMC - SSTL	CABINET ONLY - See Supply Fixtures for Pre-pipes Assemblies	
	for ET71-1 Valve	\$1,160
	for ET71-2 Valve	\$1,393
	for ET71-3 Valve or ET71-4 Valve	\$1,496
DRS	Solid Door with Lock	N/C
DRV	View Port to Door – read Temp Gauge w/o opening door	\$180

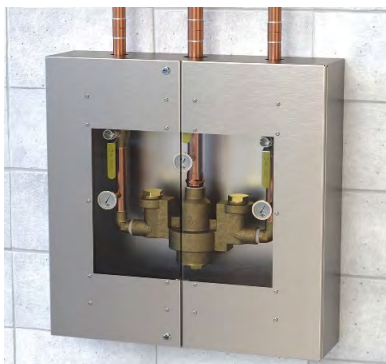



2021 LIST PRICE GUIDE FOR SHOWERING & TEMPERING PRODUCTS

Division of Acorn Engineering Company®, Member of Morris Group International™

PRICES SUBJECT TO CHANGE / All Pricing in US\$ effective June 14, 2021

Lead Free Master Mixer, Single Valve Hi-Lo

MV17 Series

ASSE 1017 Certified



Temperature Actuated Mixing Valves for Hot Water Distribution Systems; Brass Body, Chrome Finish Body and 5 size/flow rate capacities are available.

Patent 9,898,017



Model	Description	Weight	Price
MV17-1	1/2" NPT Ball Valves, Brass Body, 15 GPM @ 45 PSID	3.5 Lbs	\$327
MV17-1-OTG	w/Outlet Temperature Gauge		\$458
MV17-2	3/4" NPT Ball Valves, Brass Body, 45 GPM @ 45 PSID	8.5 Lbs	\$991
MV17-2-OTG	w/Outlet Temperature Gauge		\$1,148
MV17-3	1" NPT Ball Valves, Brass Body, 90 GPM @ 45 PSID	37 Lbs	\$1,319
MV17-3-OTG	w/Outlet Temperature Gauge		\$1,515
MV17-4	1-1/4" NPT Ball Valves, Brass Body, 150 GPM @ 45 PSID	37 Lbs	\$1,637
MV17-4-OTG	w/Outlet Temperature Gauge		\$1,867
MV17-5	2" NPT Ball Valves, Brass Body, 225 GPM @ 45 PSID	45 Lbs	\$2,812
MV17-5-OTG	w/Outlet Temperature Gauge		\$3,081
MV17CP-1	MV17-1 w/Chrome Finish	3.5 Lbs	\$441
MV17-1-OTG	w/Outlet Temperature Gauge		\$629
MV17CP-2	MV17-2 w/Chrome Finish	8.5 Lbs	\$1,441
MV17CP-2-OTG	w/Outlet Temperature Gauge		\$1,667
MV17CP-3	MV17-3 w/Chrome Finish	37 Lbs	\$1,830
MV17CP-3-OTG	w/Outlet Temperature Gauge		\$2,099
MV17CP-4	MV17-4 w/Chrome Finish	37 Lbs	\$2,222
MV17CP-4-OTG	w/Outlet Temperature Gauge		\$2,558
MV17CP-5	MV17-5 w/Chrome Finish	45 Lbs	\$3,170
MV17CP-5-OTG	w/Outlet Temperature Gauge		\$3,563

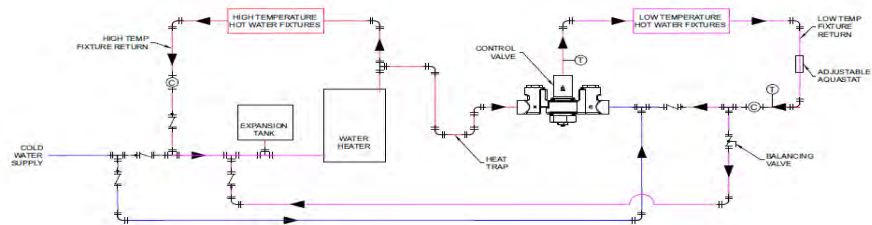



2021 LIST PRICE GUIDE FOR SHOWERING & TEMPERING PRODUCTS

Division of Acorn Engineering Company®, Member of Morris Group International™

PRICES SUBJECT TO CHANGE / All Pricing in US\$ effective June 14, 2021

Options – Lead Free Master Mixer, Single Valve Hi-Lo

Options	Description	Add Price
Mounting Brackets		
MB-1	for MV17-1 Valve	\$17
MB-2	for MV17-2 Valve	\$27
MB-3	for MV17-3 & MV17-4 Valve	\$54
MB-5	for MV17-5	\$87
Cabinets		
SMC - PRC	CABINET ONLY - See Supply Fixtures for Pre-piped Assemblies	
	for MV17-1 Valve	\$809
	for MV17-2 Valve	\$856
	for MV17-3 Valve or MV17-4 Valve	\$908
	for MV17-5	\$1,045
SMC - SSTL	CABINET ONLY - See Supply Fixtures for Pre-pipes Assemblies	
	for MV17-1 Valve	\$1,160
	for MV17-2 Valve	\$1,393
	for MV17-3 Valve or MV17-4 Valve	\$1,496
	for MV17-5	\$1,738
DRS	Solid Door with Lock	N/C
DRV	View Port to Door – read Temp Gauge w/o opening door	\$180

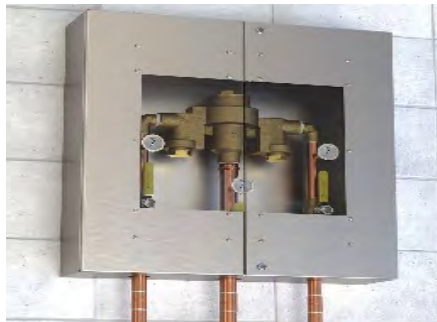



2021 LIST PRICE GUIDE FOR SHOWERING & TEMPERING PRODUCTS

Division of Acorn Engineering Company®, Member of Morris Group International™

PRICES SUBJECT TO CHANGE / All Pricing in US\$ effective June 14, 2021

Pre-Piped Supply Fixtures

SFET Series



Lead Free supply fixture utilizing the ET71 Series Valves; Deliver safe, tepid water for emergency drench equipment; Controls temperature for both recirculating and non-circulating supply system; 4 size/flow rate capacities are available.

Model	Description	Price
SFET-1	12 GPM (45 LPM), 1/2" Inlet & Outlet Brass Body	\$1,017
SFET-2	43 GPM (163 LPM), 3/4" NPT Inlet, 1" NPT Outlet Brass Body	\$1,398
SFET-3	86 GPM (326 LPM), 1" NPT Inlet, 1-1/4" NPT Outlet Brass Body	\$1,917
SFET-4	150 GPM (568 LPM), 1-1/4" NPT Inlet, 1-1/2" NPT Outlet Brass Body	\$2,754

SFMV Series



Lead Free supply fixture utilizing the MV17 Series Valves; Controls temperatures in hot water distribution systems; Can be used with recirculating and non-recirculating systems depending on specific fixture set up; Brass Body, Chrome Body and 5 size/flow rate capacities are available.



Model	Description	Price
SFMV-1	15 GPM (57 LPM), 1/2" Inlet & Outlet, Brass Body	\$1,091
SFMV-2	45 GPM (170 LPM), 3/4" Inlet, 1" Outlet, Brass Body	\$1,751
SFMV-3	90 GPM (341 LPM), 1" Inlet, 1-1/4" Outlet, Brass Body	\$2,098
SFMV-4	150 GPM (568 LPM), 1-1/4" Inlet, 1-1/2" Outlet, Brass Body	\$2,799
SFMV-5	225 GPM (852 LPM), 1-1/2" Inlet, 2" Outlet, Brass Body	\$4,298
SFMVCP-1	12 GPM (45 LPM), 1/2" Inlet & Outlet, Brass Body, Chrome Finish	\$1,455
SFMVCP-2	45 GPM (170 LPM), 3/4" Inlet, 1" Outlet, Brass Body, Chrome Finish	\$2,034
SFMVCP-3	90 GPM (341 LPM), 1" Inlet, 1-1/4" Outlet, Brass Body, Chrome Finish	\$2,503
SFMVCP-4	150 GPM (568 LPM), 1-1/4" Inlet, 1-1/2" Outlet, Brass Body, Chrome	\$3,260
SFMVCP-5	225 GPM (852 LPM), 1-1/2" Inlet, 2" Outlet, Brass Body, Chrome Finish	\$5,245

SFMV Series



Lead Free supply fixture utilizing ST7069 Valve; Delivers safe, tempered water to point of use fixtures such as sinks, baths and showers; Ideal for commercial, institutional or residential applications.



Model	Description	Price
SFST	12 GPM (45 LPM), 1/2" Inlet & Outlet Brass Body	\$1,075



2021 LIST PRICE GUIDE FOR SHOWERING & TEMPERING PRODUCTS

Division of Acorn Engineering Company®, Member of Morris Group International™

PRICES SUBJECT TO CHANGE / All Pricing in US\$ effective June 14, 2021

Options for Supply Fixtures (Applies to SFST, SFET & SFMV Series)

		Pipe Orientation	Price
T	Top Supply Inlet		No extra charge
B	Bottom Supply Inlet		No extra charge
OT	Outlet Top		No extra charge
OB	Outlet Bottom		No extra charge
OSL	Outlet Right Side		No extra charge
OSR	Outlet Right Side		No extra charge

		CW By-Pass	
	CWB	for SFST, SFMV-1	\$506
		for SFMV-2	\$788
		for SFMV-3	\$900
		for SFMV-4	\$1,012
		for SFMV-5	\$1,349
		for SFMVCP-1	\$618
		for SFMVCP-2	\$900
		for SFMVCP-3	\$1,012
		for SFMVCP-4	\$1,125
		for SFMVCP-5	\$1,462

		Inlet Temperature Gauges	
	ITG	for SFST, SFMV-1, SFET-1	\$219
		for SFMV-2, SFET-2	\$281
		for SFMV-3, SFET-3	\$320
		for SFMV-4, SFET-4	\$341
		for SFMV-5	\$394
		for SFMVCP-1	\$276
		for SFMVCP-2	\$337
		for SFMVCP-3	\$378
		for SFMVCP-4	\$394
		for SFMVCP-5	\$449



2021 LIST PRICE GUIDE FOR SHOWERING & TEMPERING PRODUCTS

Division of Acorn Engineering Company®, Member of Morris Group International™

PRICES SUBJECT TO CHANGE / All Pricing in US\$ effective June 14, 2021

Options for Supply Fixtures (Applies to SFST, SFET & SFMV Series)

CABINET STYLE & FINISH		Price
RC-PRC	Recessed Cabinet w/Prime Coat Finish	
	for SFST, SFET-1, SFMV-1, SFMVCP-1	\$878
	for SFET-2, SFMV-2, SFMVCP-2	\$933
	for SFMV-3, SFMVCP-3, SFET-3, SFMV-4, SFMVCP-4, SFET-4	\$983
	for SFMV-5, SFMVCP-5	\$1,109
RC-SSTL	Recessed Stainless Steel Cabinet	
	for SFST, SFET-1, SFMV-1, SFMVCP-1	\$1,289
	for SFET-2, SFMV-2, SFMVCP-2	\$1,548
	for SFMV-3, SFMVCP-3, SFET-3, SFMV-4, SFMVCP-4, SFET-4	\$1,662
	for SFMV-5, SFMVCP-5	\$1,937
SMC-PRC	Surface Mount Cabinet w/Prime Coat Finish	
	for SFST, SFET-1, SFMV-1, SFMVCP-1	\$878
	for SFET-2, SFMV-2, SFMVCP-2	\$933
	for SFMV-3, SFMVCP-3, SFET-3, SFMV-4, SFMVCP-4, SFET-4	\$983
	for SFMV-5, SFMVCP-5	\$1,109
SMC-SSTL	Surface Mount Stainless Steel Cabinet	
	for SFST, SFET-1, SFMV-1, SFMVCP-1	\$1,289
	for SFET-2, SFMV-2, SFMVCP-2	\$1,548
	for SFMV-3, SFMVCP-3, SFET-3, SFMV-4, SFMVCP-4, SFET-4	\$1,662
	for SFMV-5, SFMVCP-5	\$1,937
OPTIONAL CABINET DOOR		
DRS	Solid Door for Cabinet	
DRV	Door with Viewport for Cabinet	\$180
L	Left Side Hinge for Door on Cabinet	No extra charge
R	Right Side Hinge for Door on Cabinet	No extra charge

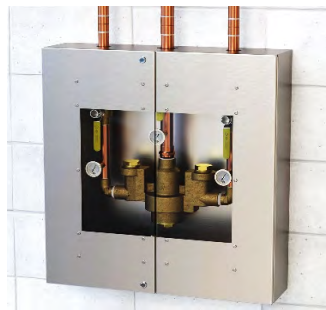



2021 LIST PRICE GUIDE FOR SHOWERING & TEMPERING PRODUCTS

Division of Acorn Engineering Company®, Member of Morris Group International™

PRICES SUBJECT TO CHANGE / All Pricing in US\$ effective June 14, 2021

Multi-Valve/Pre-Piped Supply Fixtures

SFMMV Series



Lead Free, Multi-Valve supply fixture utilizing the MV17 Series. Deliver safe, tempered water for commercial or institutional facilities. Controls temperature for both recirculating and non-circulating supply system; capacities range from 0 to over 1,000 gpm.

Call/E-Mail for Pricing

Systems are configurable for

Standard Configurations (Specials available on Request)

The ET71 series can be used in these systems also.

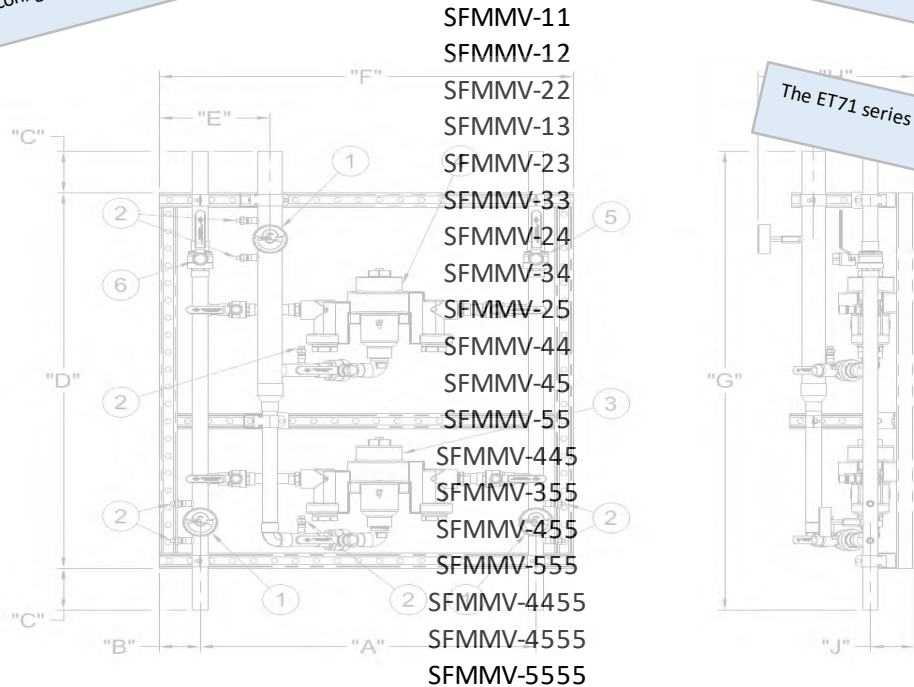

The ET71 series can be used in these systems also.



2021 LIST PRICE GUIDE FOR SHOWERING & TEMPERING PRODUCTS

Division of Acorn Engineering Company®, Member of Morris Group International™

PRICES SUBJECT TO CHANGE / All Pricing in US\$ effective June 14, 2021

Self-Contained Tempering & Recirculation System

Command Station CSMV Series



Lead Free fully assembled tempering/recirculation system featuring the MV17 series. Delivers safe, tempered water for commercial and institutional facilities. Command Stations are designed with engineer specified pumps and controls for fast and easy start-ups.

Call/E-Mail for Pricing

Systems are configurable for

Standard Configurations (Specials available on Request)

The ET71 series can be used in these systems

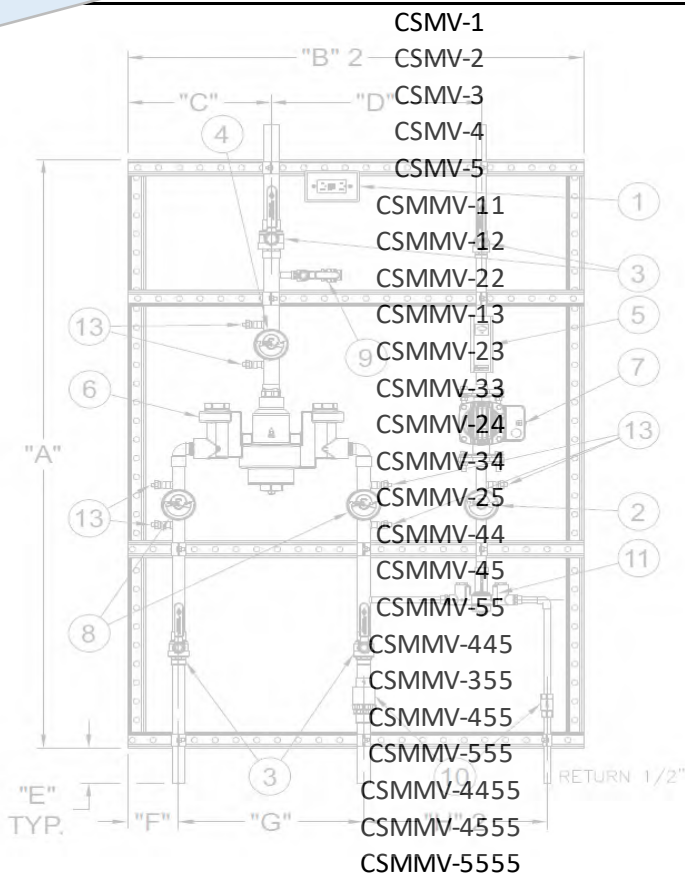

Configurable Ordering Codes

Emergency Tempering Skids

STS-1	120 Gallon NON-ASME Tank with ET71-2 tempering valve
STS-1A	120 Gallon ASME Tank with ET71-2 tempering valve
STS-3	300 Gallon ASME Tank with ET71-3 tempering valve
STS-1 Special	Per specifications - please allow 3 to 5 days for a proposal, more if a detailed submittal is required.

Call or E-Mail Acorn Controls for Quotes



2021 LIST PRICE GUIDE FOR SHOWERING & TEMPERING PRODUCTS

Division of Acorn Engineering Company®, Member of Morris Group International™

PRICES SUBJECT TO CHANGE / All Pricing in US\$ effective June 14, 2021

Digital Tempering & Recirculation System

Acorn BASyC ABMV Series



Lead Free fully assembled Digital tempering/recirculation system featuring the MV17 series. Delivers safe, tempered water for commercial and institutional facilities. Command Stations are designed with engineer specified pumps and controls for fast and easy start-ups.

Call/E-Mail for Pricing

Standard Configurations (Specials available on Request)

Systems are configurable for

The ET71 series can be used in these systems also.

- ABMV-2
- ABMV-3
- ABMV-4
- ABMV-5
- ABMMV-1
- ABMMV-
- ABMMV-33
- ABMMV-24
- ABMMV-34
- ABMMV-25
- ABMMV-44
- ABMMV-45
- ABMMV-55
- ABMMV-445
- ABMMV-355
- ABMMV-455
- ABMMV-555
- ABMMV-4455
- ABMMV-4555
- ABMMV-5555

- Upgraded Controller - Smaller & Faster w/more Memory &



Configurable Ordering Codes

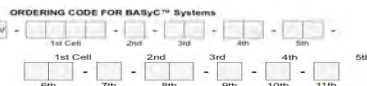



2021 LIST PRICE GUIDE FOR SHOWERING & TEMPERING PRODUCTS

Division of Acorn Engineering Company®, Member of Morris Group International™

PRICES SUBJECT TO CHANGE / All Pricing in US\$ effective June 14, 2021

TempFlow™ Thermostatic Balancing Valve

TZV Series



TempFlow is a thermostatically controlled, adjustable, lead-free, zone balancing valve that maintains hot water zone temperatures. Valves self balance enabling fast and easy start-up of complex plumbing systems.

Model	Description	In Stock	Price
TZV-0001	TempFlow w/Capped Test Port	X	\$143
TZV-2101	TempFlow w/2 BV's, OTG & Capped Test Port	X	\$303
TZV-2111	TempFlow w/2 BV's, OTG, Union & Capped Test Port	X	\$329
TZV-3110	TempFlow w/3 BV's, OTG, Union & Capped Test Port	X	\$343

Configurable Numbering System

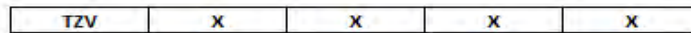

Test Port		List
0	Un-Capped	\$0
1	Capped	\$9

Union		List
0	none	\$0
1	included	\$25

Temperature Gauge/Tee		List
0	none	\$0
1	OTG	\$115

Lockable BV		List
0	none	\$0
1	one	\$23
2	two	\$46
3	three	\$69

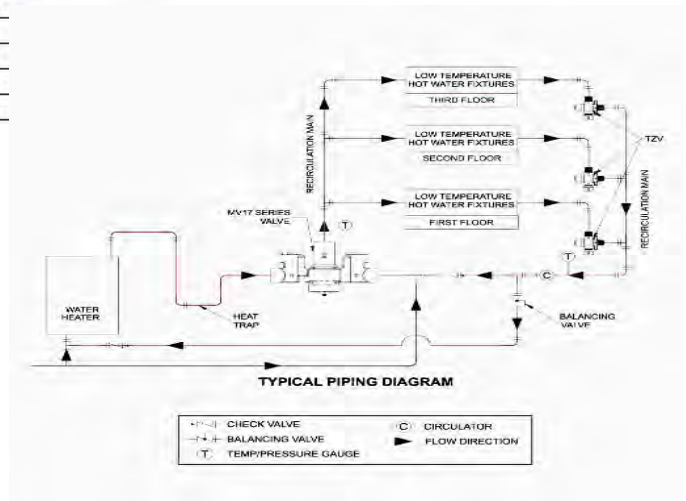
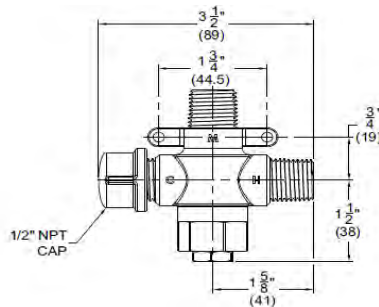



2021 LIST PRICE GUIDE FOR SHOWERING & TEMPERING PRODUCTS

Division of Acorn Engineering Company®, Member of Morris Group International™

PRICES SUBJECT TO CHANGE / All Pricing in US\$ effective June 14, 2021

ATM (Automatic Temperature Monitor)

ATM-1	Base Price Includes the ATM, the thermocouple sensor with 10 feet of signal wire and compression fitting and 24 VAC transformer	\$1,195
--------------	---	---------

Options

Thermocouple "Tee" and adapters		Price
	1/2"	\$27
	3/4"	\$34
	1"	\$49
	1 1/4"	\$71
	1 1/2"	\$100
	2"	\$138
Normally Closed Solenoid		
	1/2"	\$315
	3/4"	\$395
	1"	\$710
	1 1/4"	\$995
	1 1/2"	\$1,175
	2"	\$1,995
Water Hammer Arrester		
	1/2"	\$215
	3/4"	\$329
	1"	\$491
	1 1/4"	\$995
	1 1/2"	\$1,399
	2"	\$1,499
Additional Sensor Wire		
	Thermocouple 10 Ft. Segment	\$27
	Solenoid 10 Ft. Segment	\$27
Wall Mounting Brackets (Pair)		\$56

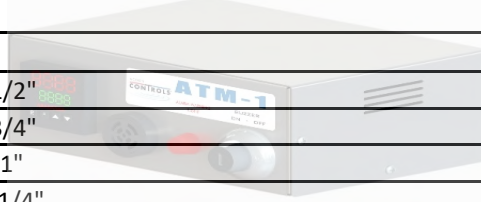



2021 PARTS PRICING FOR SHOWERING & TEMPERING PRODUCTS

Division of Acorn Engineering Company®, Member of Morris Group International™

PRICES SUBJECT TO CHANGE / All Pricing in US\$ effective June 14, 2021

SV16

Acorn P/N	Description	List Price
7800-503-001	Trim Kit - Lever	\$81
7800-186-001	Trim Kit - Ligature. Resist.	\$79
7800-500-001	Complete Internal Rebuild Kit	\$149
7800-502-001	Cartridge/Bonnet Replacement	\$118
7800-175-001	Cartridge Replacement Kit	\$89
7800-504-001	Check Stop Rebuild Kit	\$38
RSV16-LVR	Includes all parts necessary for upgrading specific Powers castings to SV16-LVR, including special instructions.	\$200
RSV16	Includes all parts necessary for upgrading specific Powers castings to SV16, including special instructions.	\$200
7800-056-001	Stem Extension	\$23

ST7069

Acorn P/N	Description	List Price
7803-500-001	Complete Rebuild Kit	\$121
7803-510-001	Internal Repair Kit	\$67
7803-502-001	Bonnet & Stem Kit	\$46
7801-503-001	Check & Strainer Rebuild Kit	\$22
7801-503-002	Check & Strainer Rebuild Kit, Less Bonnet	\$17

ET71-1

Acorn P/N	Description	List Price
7801-500-001	Complete Rebuild Kit	\$174
7801-510-001	Internal Repair Kit	\$116
7801-502-001	Bonnet & Stem Kit	\$58
7801-503-001	Check & Strainer Rebuild Kit	\$23
7801-503-002	Check & Strainer Rebuild Kit, Less Bonnet	\$17
7801-504-001	By-Pass Rebuild Kit	\$25
7801-504-002	By-Pass Rebuild Kit, Less Bonnet	\$21



2021 PARTS PRICING FOR SHOWERING & TEMPERING PRODUCTS

Division of Acorn Engineering Company®, Member of Morris Group International™

ET71-2

Acorn P/N	Description	List Price
7804-500-001	Complete Rebuild Kit	\$499
7804-510-001	Internal Repair Kit	\$308
7804-502-001	Bonnet & Stem Kit	\$188
7804-503-001	Check & Strainer Rebuild Kit	\$62
7804-503-002	Check & Strainer Rebuild Kit, Less Bonnet	\$26
7804-504-001	By-Pass Rebuild Kit	\$41
7804-504-002	By-Pass Rebuild Kit, Less Bonnet	\$32

ET71-3

Acorn P/N	Description	List Price
7808-500-001	Complete Rebuild Kit	\$790
7808-510-001	Internal Repair Kit	\$491
7808-502-001	Bonnet & Stem Kit	\$307
7808-503-001	Check & Strainer Rebuild Kit	\$91
7808-503-002	Check & Strainer Rebuild Kit, Less Bonnet	\$47
7808-504-001	By-Pass Rebuild Kit	\$65
7808-504-002	By-Pass Rebuild Kit, Less Bonnet	\$53

ET71-4

Acorn P/N	Description	List Price
7805-500-001	Complete Rebuild Kit	\$868
7805-510-001	Internal Repair Kit	\$573
7805-502-001	Bonnet & Stem Kit	\$313
7808-503-001	Check & Strainer Rebuild Kit	\$91
7808-503-002	Check & Strainer Rebuild Kit, Less Bonnet	\$47
7808-504-001	By-Pass Rebuild Kit	\$65
7808-504-002	By-Pass Rebuild Kit, Less Bonnet	\$53

MV17-1

Acorn P/N	Description	List Price
7806-500-001	Complete Rebuild Kit	\$124
7806-510-001	Internal Repair Kit	\$71
7806-502-001	Bonnet & Stem Kit	\$46
7801-503-001	Check & Strainer Rebuild Kit	\$23
7801-503-002	Check & Strainer Rebuild Kit, Less Bonnet	\$17



2021 PARTS PRICING FOR SHOWERING & TEMPERING PRODUCTS

Division of Acorn Engineering Company®, Member of Morris Group International™

MV17CP-1

Acorn P/N	Description	List Price
7806-500-010	Complete Rebuild Kit	\$155
7806-510-010	Internal Repair Kit	\$89
7806-502-010	Bonnet & Stem Kit	\$57
7801-503-010	Check & Strainer Rebuild Kit	\$28
7801-503-002	Check & Strainer Rebuild Kit, Less Bonnet	\$17

MV17-2

Acorn P/N	Description	List Price
7812-500-001	Complete Rebuild Kit	\$440
7812-510-001	Internal Repair Kit	\$264
7812-502-001	Bonnet & Stem Kit	\$170
7804-503-001	Check & Strainer Rebuild Kit	\$62
7804-503-002	Check & Strainer Rebuild Kit, Less Bonnet	\$26

MV17CP-2

Acorn P/N	Description	List Price
7812-500-010	Complete Rebuild Kit	\$550
7812-510-010	Internal Repair Kit	\$330
7812-502-010	Bonnet & Stem Kit	\$213
7804-503-010	Check & Strainer Rebuild Kit	\$77
7804-503-002	Check & Strainer Rebuild Kit, Less Bonnet	\$26

MV17-3

Acorn P/N	Description	List Price
7810-500-001	Complete Rebuild Kit	\$539
7810-510-001	Internal Repair Kit	\$315
7810-502-001	Bonnet & Stem Kit	\$195
7808-503-001	Check & Strainer Rebuild Kit	\$91
7808-503-002	Check & Strainer Rebuild Kit, Less Bonnet	\$88

MV17CP-3

Acorn P/N	Description	List Price
7810-500-010	Complete Rebuild Kit	\$673
7810-510-010	Internal Repair Kit	\$394
7810-502-010	Bonnet & Stem Kit	\$251
7808-503-010	Check & Strainer Rebuild Kit	\$113
7808-503-002	Check & Strainer Rebuild Kit, Less Bonnet	\$47



2021 PARTS PRICING FOR SHOWERING & TEMPERING PRODUCTS

Division of Acorn Engineering Company®, Member of Morris Group International™

MV17-4

Acorn P/N	Description	List Price
7809-500-001	Complete Rebuild Kit	\$655
7809-510-001	Internal Repair Kit	\$394
7809-502-001	Bonnet & Stem Kit	\$253
7808-503-001	Check & Strainer Rebuild Kit	\$91
7808-503-002	Check & Strainer Rebuild Kit, Less Bonnet	\$47

MV17CP-4

Acorn P/N	Description	List Price
7809-500-010	Complete Rebuild Kit	\$905
7809-510-010	Internal Repair Kit	\$551
7809-502-010	Bonnet & Stem Kit	\$355
7808-503-010	Check & Strainer Rebuild Kit	\$113
7808-503-002	Check & Strainer Rebuild Kit, Less Bonnet	\$47

MV17-5

Acorn P/N	Description	List Price
7811-500-001	Complete Rebuild Kit	\$891
7811-510-001	Internal Repair Kit	\$555
7811-502-001	Bonnet & Stem Kit	\$357
7808-503-001	Check & Strainer Rebuild Kit	\$91
7808-503-002	Check & Strainer Rebuild Kit, Less Bonnet	\$47

MV17CP-5

Acorn P/N	Description	List Price
7811-500-010	Complete Rebuild Kit	\$1,049
7811-510-010	Internal Repair Kit	\$650
7811-502-010	Bonnet & Stem Kit	\$418
7808-503-010	Check & Strainer Rebuild Kit	\$113
7808-503-002	Check & Strainer Rebuild Kit, Less Bonnet	\$47